

XCR110L5越野轮胎起重机 / Rough Terrain Crane

技术规格书

Technical specifications



110t



51m



64.2m



目录

Contents

目录	
Contents	
尺寸参数	3
Dimensions	
技术规格	4-5
Technical specifications	
重量/作业速度	6
Weight / Working speeds	
平衡重	7
Counterweight	
臂架组合方案	8-9
Boom / Jib combinations	
主臂	10-12
Boom	
副臂	13-15
Jib	
符号标识	16
Description of symbols	
主要技术参数表	17-18
Table of main technical parameters	
注意事项	19
Notes	

尺寸参数 Dimensions

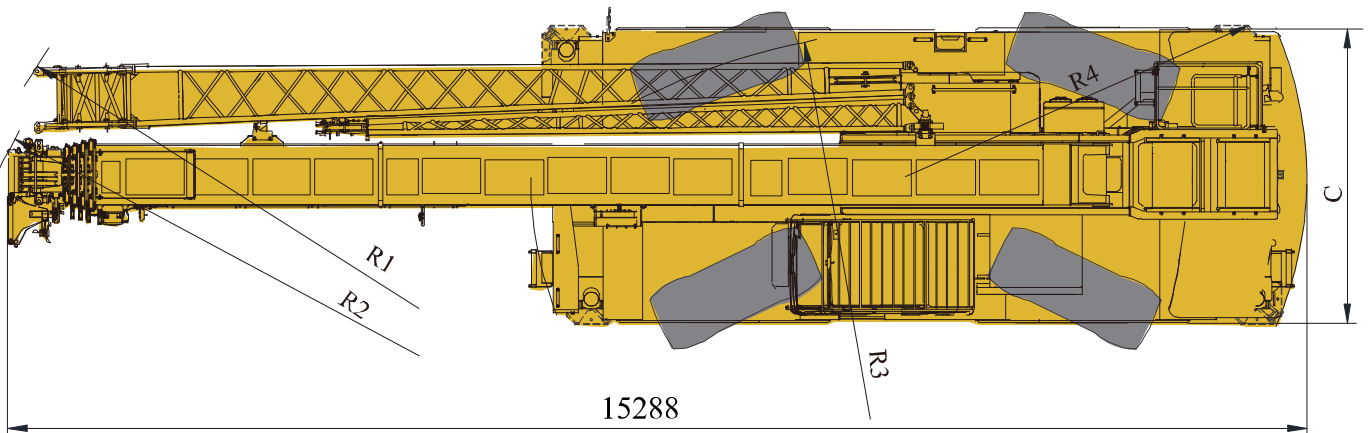
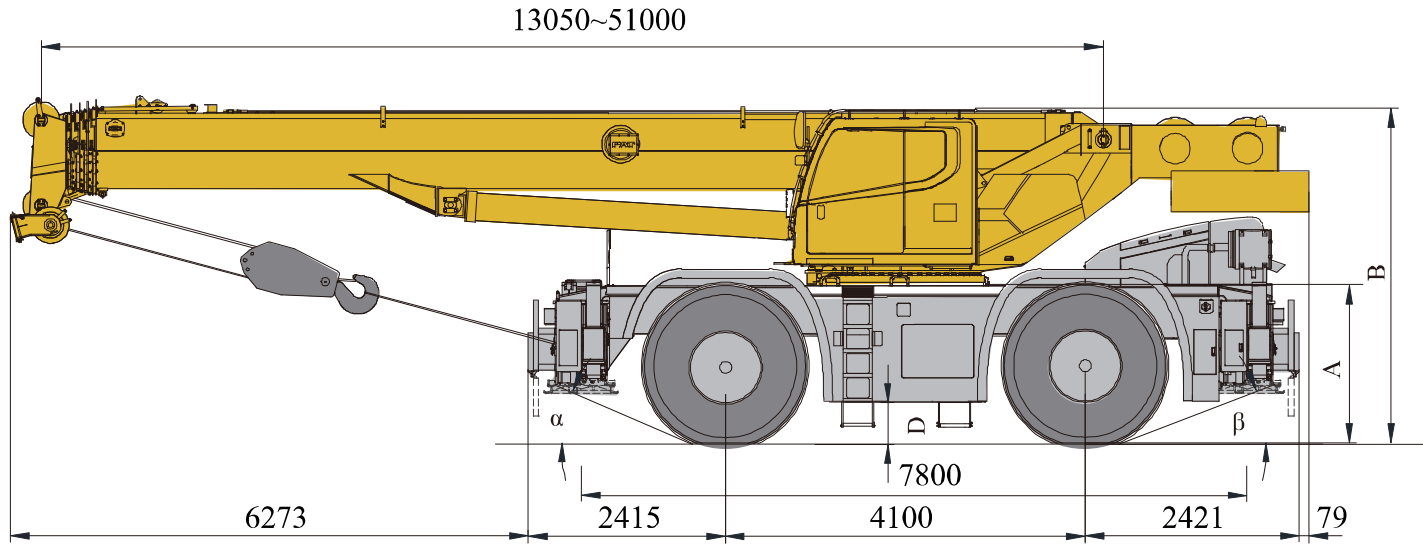

	α	β	A	B	C	D	R1	R2	R3	R4
29.5R25	20.1°	20.1°	1840	3893	3300	524	12403	12033	6800	4600

技术规格

Technical specifications

		配置	
主臂	<p>1节基本臂和4节伸缩臂，U形截面的焊接结构，双缸绳排伸缩机构。臂头标配6个滑轮。</p> <p>主臂长度：13.05m~51m。</p>	●	<p>制动</p> <p>行车制动：双回路全液压盘式制动，作用于所有车轮；当系统压力过低时，具有自动报警、自动制动功能。</p> <p>驻车制动：弹簧加载、液压解除的独立盘式制动器，作用于前桥。</p>
副臂	<p>2节，桁架式结构，0°、15°和30°三种安装角度，安装在主臂侧面。</p> <p>副臂长度：9.5m~16m。</p>	●	<p>液压系统</p> <p>双变量柱塞泵用于起升、变幅、伸缩，齿轮泵用于回转、支腿、转向、制动等动作；主阀采用负载敏感式比例多路换向阀；配置独立的液压油散热器；</p> <p>液压油箱容积：约1163L。</p>
车架	<p>车架采用细晶粒高强度钢焊接而成，抗扭转大截面框架结构，承载能力强。</p>	●	<p>操纵方式</p> <p>液控先导操纵系统，由左右2个操纵手柄控制起重机的主要动作。</p>
支腿	<p>4支腿，H型布置，位于车架两端，由电控液压控制。</p>	●	<p>电气系统</p> <p>直流24伏特，2块12伏电瓶串联。</p> <p>配有力矩限制器和前照灯、转向灯、倒车灯、转台工作灯、吊臂工作灯、回转警示灯等。</p>
发动机	<p>东风康明斯ISD285 50，额定功率210/2500(kW/(r/min))，最大输出扭矩1020/(1300-1500)(N.m/(r/min))；直列六缸水冷压燃式柴油发动机，道路欧五排放标准</p> <p>燃油箱有效容积：约305L。</p>	●	<p>主、副起升机构</p> <p>由液压马达通过行星齿轮减速器驱动，内置常闭式制动器并带有平衡阀。</p>
变速箱	<p>MYF230AM-CR，液力自动变速箱，8个前进档3个倒档。</p>	●	<p>回转机构</p> <p>单排四点接触球式回转支承，液压马达驱动内置行星齿轮减速器，减速机配备常闭式制动器。</p>
车桥	<p>前后桥均为转向驱动桥，承载能力大。</p>	●	<p>司机室</p> <p>翻转式司机室，滑移式车门，可调式座椅，装有安全玻璃、顶部保护栏，前风窗及顶部装有遮阳帘。</p> <p>配置冷暖空调、收音机、12V和24V电源接口。</p>
悬挂	<p>前桥与车架刚性连接；</p> <p>后桥采用摆动式液压悬架，公路行驶具有减震功能，缓冲路面冲击；吊重行驶时后悬架油缸锁止至刚性状态，增加作业稳定性。</p>	●	<p>安全装置</p> <p>配有液压平衡阀、溢流阀、双向锁、LMI；三圈保护器，防止钢丝绳过放；臂头设置高度限位器、防止钢丝绳过卷。</p>
轮胎	<p>4个专用越野轮胎，每桥均装单胎，承载能力大。</p> <p>轮胎规格：29.5R25。</p>	●	<p>平衡重</p> <p>总重13.8t。</p>
转向	<p>具有前桥独立转向、小转弯转向、蟹行转向和后桥独立四种转向功能。模式切换时可实现转角自调整。</p>	●	<p>吊钩</p> <p>55 t 吊钩，7t 吊钩。</p> <p>80 t 吊钩</p> <p>其他</p> <p>倒车影像+卷扬监视</p>

产品各部件明细如上所述，具体部件明细请

参照产品报价单

符号说明：

- —— 表示标准配置；
- —— 表示选装配置。

技术规格

Technical specifications

		
Boom	1 basic boom and 4-telescoping sections, U-shape cross section welding structure. Double cylinder plus ropes telescoping mechanism. 6 pulleys on boom head are standard. Boom length: 13.05m ~ 51 m.	●
Jib	Two-section lattice structure. Three offset angles of 0° , 15° and 30° are available. It is stowed along the side of the boom. Jib length 9.5m~16 m.	●
Frame	Made of high strength fine grained steel, welded torsion-resistant frame type construction with large cross-section, high load-bearing capacity.	●
Outrigger	4 outriggers, H-shaped arrangement, which are controlled by electrical and hydraulic and located at both sides of chassis frame.	●
Engine	DF Cummins ISD285 50, with rated power of 210/2500(kW/(r/min)), max. torque of 1020/(1300-1500)(N.m/(r/min)), in line, six-cylinder water-cooled compression ignition diesel engine, European V emission standard. Fuel tank capacity: Approx. 305 L.	●
Transmission	MYF230AM-CR , hydraulic automatic transmission, with 8 forward and 3 reverse gears	●
Axles	Both front and rear axles are for driving and steering, and the axles have features of great load bearing capacity	●
Suspensions	Front axle is rigidly connected with frame; rear axle is equipped with swing hydraulic suspensions, which have cushioning function when driving on roads; the rear suspension cylinder may be locked to rigid state so as to meet the requirement for travel with a load suspended, increasing operation stability.	●
Tires	4 specialized off-road, large bearing capacity. Tire specifications: 29.5R25.	●
Steering	Front axle independent steering, tight turning radius steering, crab walk steering and rear axle independent steering modes are available. The steering angle can be self-adjusted when changing mode.	●
Brakes	Service brake: double-circuit hydraulic disc brake, acting on all wheels. Automatically braking and alarm are available when the pressure in braking system is too low. Parking brake: spring-loaded brake, acting on front axles, hydraulic-released independent disc brake.	●
Hydraulic system	A dual-variable displacement pump, used for hoisting, elevating and telescoping operations, and a gear pump, used for slewing, outrigger, steering and braking operations; a load sensitive proportional multi-way change valve is used as main valve; an independent hydraulic oil radiator. Tank capacity: approx. 1163L.	●
Operating mode	Hydraulic controlled pilot operation system is equipped with two levers controlling the main movements of the crane.	●
Electrical System	24 V DC, two sets of 12 V battery in series.	●
Main \Auxiliary winch system	The system is driven by a hydraulic motor through a planetary gear reducer, with a normally closed brake and a balance valve equipped.	●
Slewing system	Single-row four-point ball contact slewing ring, driven by a hydraulic motor through planetary gear reducer, and with a normally closed brake fitted.	●
Operator's cab	Tiltable cab, with sliding door and adjustable seat equipped. It is equipped with safe glass and roof protective grille. Sun shade is available for windshield and roof window. Heater and air conditioner, radio, 12 V and 24 V DC outlets are standard.	●
Safety devices	Hydraulic balance valve, hydraulic relief valve, hydraulic double-way valve and LMI. Lowering limiter is equipped in winch to prevent rope over-releasing. Anti-two block is fitted on the boom head to prevent rope over-winding.	●
Counterweight	13.8 t	●
Hook Block	55 t hook block, 7 t hook block 80 t hook block	● ○
Other	Reverse camera + winch monitoring device	○

Product parts list is as mentioned above. Please refer to the product quotation for specific parts.
Symbol explanation:
 ● — it means the standard configuration;
 ○ — it means the optional configuration.

重量 Weight



车桥 Axle	1	2	整车总重量 Gross vehicle weight
t	29.34	29.57	58.91



吊钩 Hook	倍率 No. of lines	吊钩重量 Weight (kg)	备注 Remarks
80t	13	700	单钩 Single hook
55t	8	470	单钩 Single hook
7t	1	210	单钩 Single hook

作业速度 Working speeds



	
29.5 R 25	35



作业机构 Drive	作业速度 Working speed	最大单绳拉力 Max. single line pull	钢丝绳直径/长度 Rope diameter/ length
	0-145 m/min, 空载, 第四层 m/min, no load, 4th layer	69kN	20mm/250m
	0-90 m/min, 空载, 第四层 m/min, no load, 4th layer	69kN	20mm/150m
	0-1.6r/min		
	从-1.5°抬起至80°约55s Approx. 55s for boom elevation from -1.5° to 80°		
	从13.05m伸出至51m约130s Approx. 130s for boom extension from 13.05m to 51m		

平衡重 Counterweight

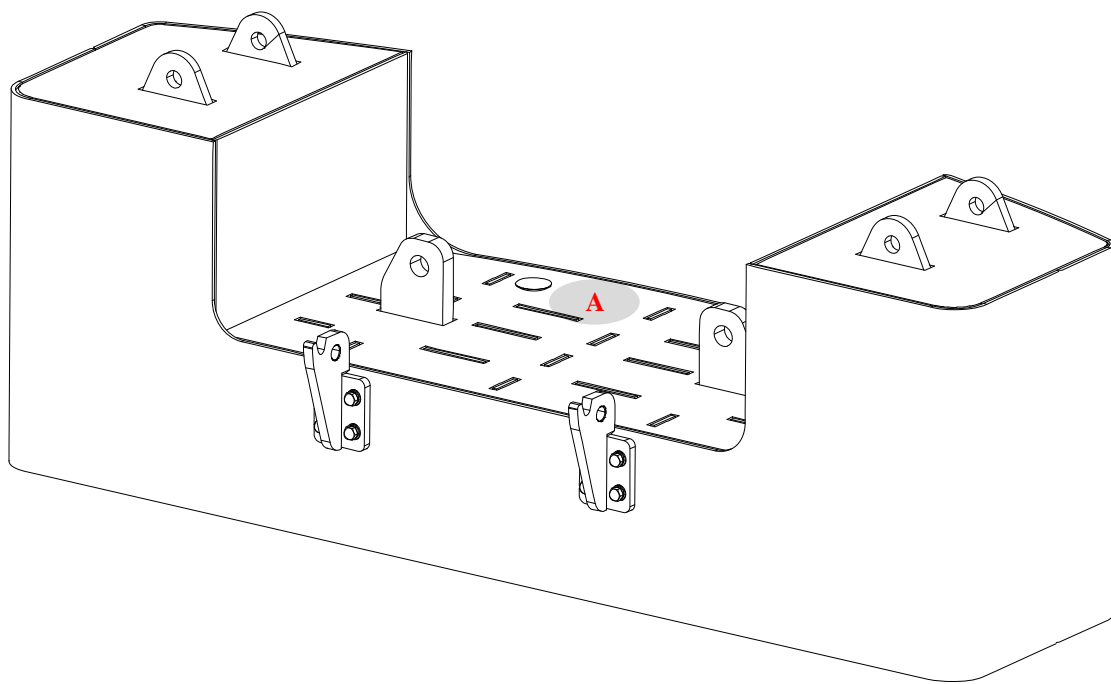

平衡重 Counterweight	A
尺寸 (长×宽×高) mm Size (L×W×H) mm	3270×1053×1215
重量 t Weight t	13.8

臂架组合方案

Boom / Jib combinations

副臂 - 9.5m
Jib - 9.5m

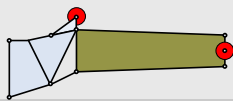

副臂 - 16m
Jib - 16m

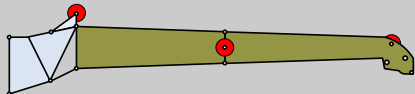

部件
Component

结构形式
Structure

尺寸 (长×宽×高) mm
Size (L×W×H) mm

重量 kg
(Weight kg)

一节、二节副臂总成+连接架
First and second jib section
assembly + Connecting bracket

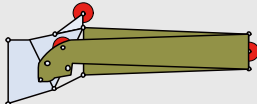

折叠 (Folded) : 10073×1033×1362

1195

臂架组合方案

Boom / Jib combinations

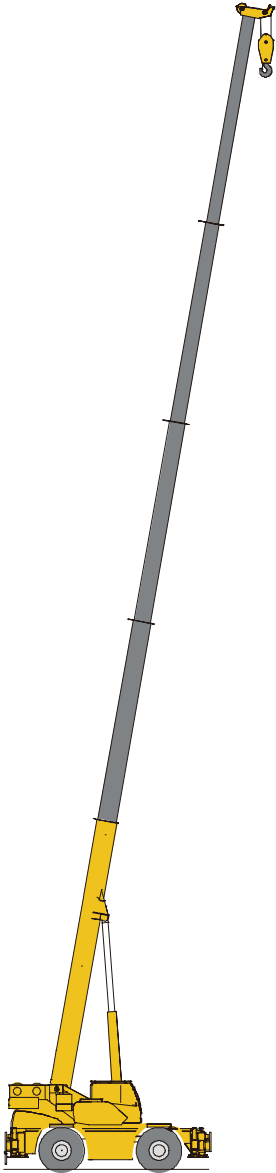

主臂
Telescopic boom

13.05~51m

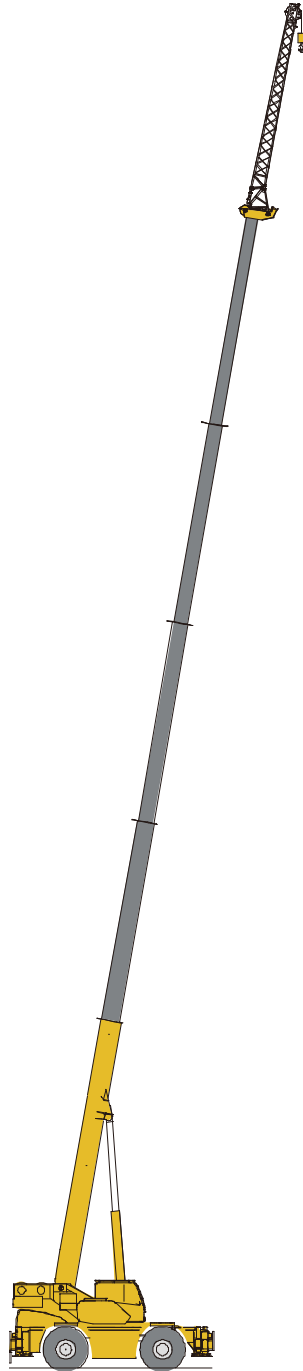

主臂 + 一节副臂
Telescopic boom + First jib section

51m+9.5m

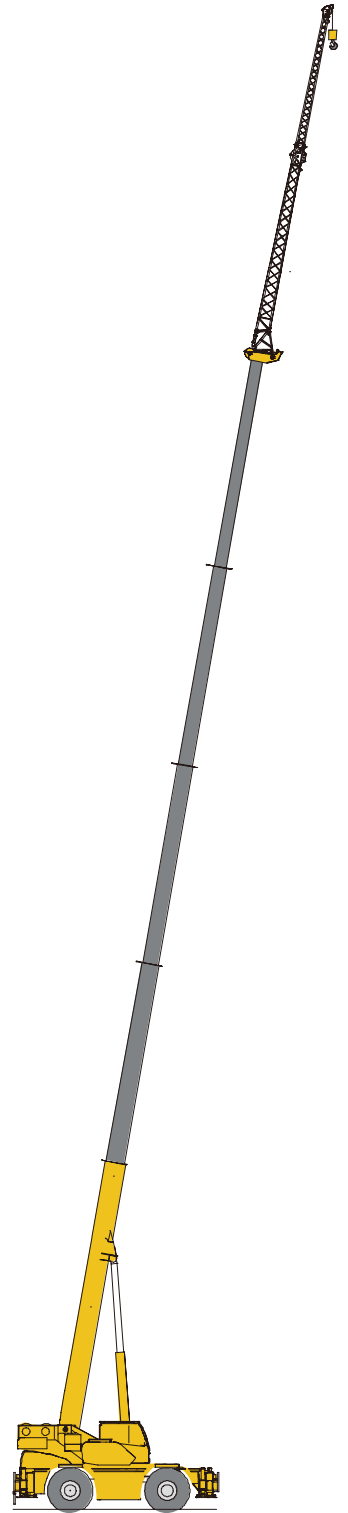

主臂 + 两节副臂
Telescopic boom + First and second jib sections

51m+16 m

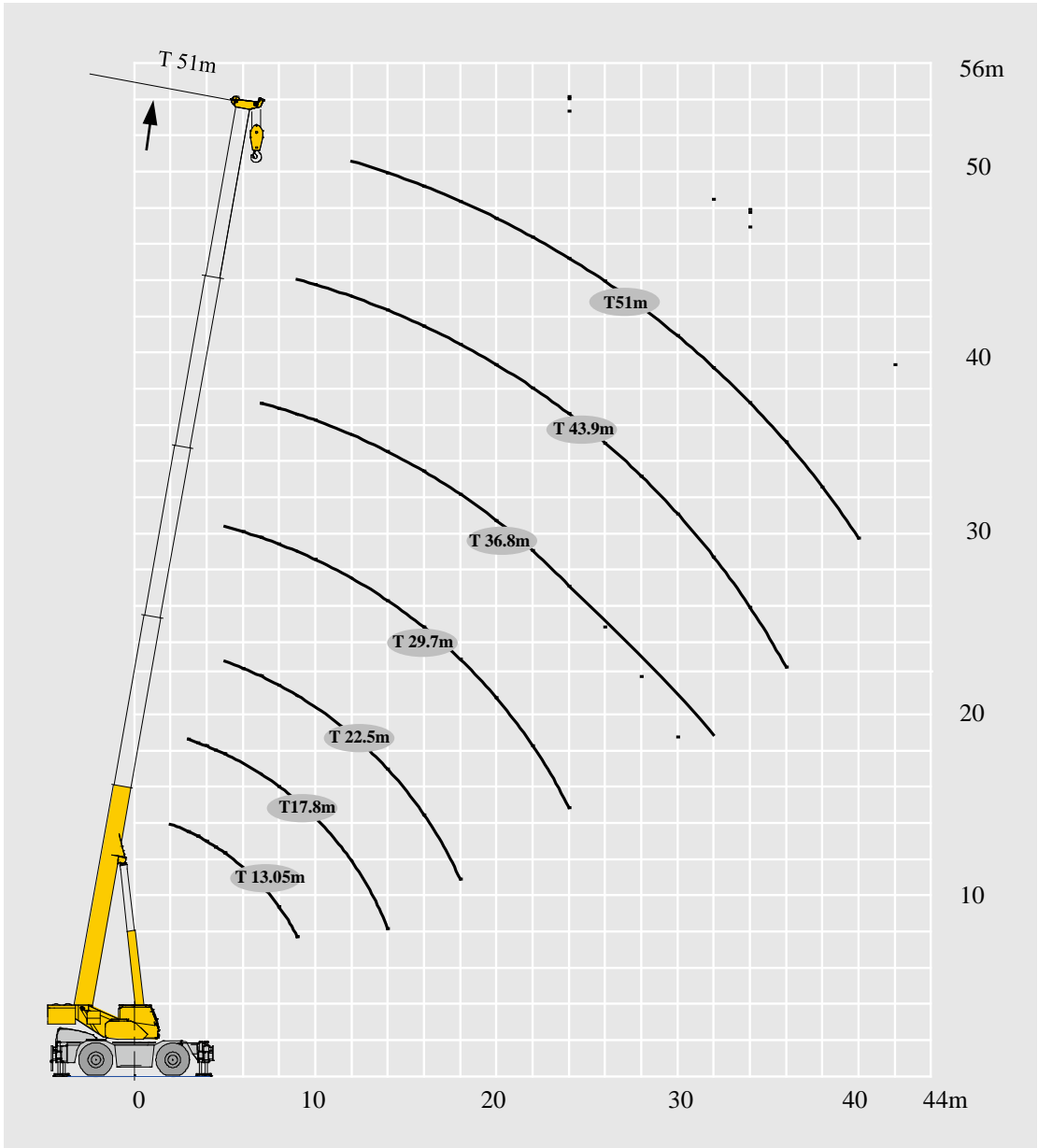

起重性能表

Lifting capacities

T 13.05~51m

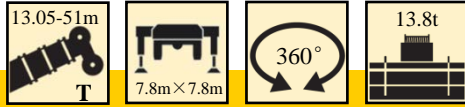

	13.05m	17.8m	22.5m	29.7m	36.8m	43.9m	51m	20.2m	27.3m	34.4m	41.5m	24.9m	32m	39.1m	46.3m	
2	110*															2
2.5	100*															2.5
3	95*	66.0														3
3.5	87*	66.0						31.0								3.5
4	78	66.0						31.0				30.5				4
4.5	68.0	60.0						31.0				30.5				4
5	62.3	59.7	40.0	32.0				31.0	27.6			30.5				5
6	52	50.5	38.9	32.0				31.0	27.6	18.5		30.5	26.7			6
7	44.5	44.2	34.8	30.0	26.0			31.0	27.6	18.5		30.5	26.7			7
8	38.5	37.5	31.3	27.3	24.3			31.0	27.6	18.5	12.1	30.5	26.7	19.2		8
9	32	33.4	28.3	24.8	22.3	18.0		31.0	26.2	18.5	12.1	30.5	26.7	19.0		9
10		26.7	25.8	22.6	20.5	17.5		29.6	24.7	17.4	12.1	28.6	26.7	17.9	13.0	10
12		18.3	17.9	19.5	17.5	15.6	12.5	20.9	21.9	15.7	12.1	20.1	21.1	16.0	12.8	12
14		13.2	12.9	14.4	15.3	13.9	11.7	15.7	16.6	14.2	11.7	14.9	15.8	14.3	11.6	14
16			9.5	11.0	11.8	12.2	10.8	12.2	13.0	12.8	10.8	11.5	12.3	12.9	10.6	16
18			7.1	8.5	9.3	9.9	9.7		10.5	11.0	9.9	9.0	9.8	10.3	9.7	18
20				6.7	7.5	8.0	8.4		8.6	9.0	9.0	7.1	7.9	8.4	8.8	20
22				5.2	6.0	6.5	6.9		7.1	7.6	7.9		6.5	7.0	7.3	22
24				4.1	4.8	5.3	5.7			6.4	6.7		5.3	5.8	6.1	24
26					3.9	4.4	4.7			5.4	5.7		4.3	4.8	5.1	26
28					3.1	3.6	3.9			4.6	4.9		3.5	4.0	4.3	28
30					2.4	2.9	3.2			3.9	4.2			3.3	3.6	30
32					1.8	2.3	2.6				3.6			2.7	3.0	32
34						1.8	2.1				3.1			2.2	2.5	34
36						1.3	1.7				2.6				2.1	36
38							1.3								1.7	38
40							1.0								1.3	40
二节臂 2nd	0	50%	100%	100%	100%	100%	100%	0%	0%	0%	0%	50%	50%	50%	50%	二节臂 2nd
三节臂 3rd	0	0	0	25%	50%	75%	100%	25%	50%	75%	100%	25%	50%	75%	100%	三节臂 3rd
四节臂 4th	0	0	0	25%	50%	75%	100%	25%	50%	75%	100%	25%	50%	75%	100%	四节臂 4th
五节臂 5th	0	0	0	25%	50%	75%	100%	25%	50%	75%	100%	25%	50%	75%	100%	五节臂 5th

* 点需使用特殊装置。

The lifting load with a * followed is available only when additional equipment is used.

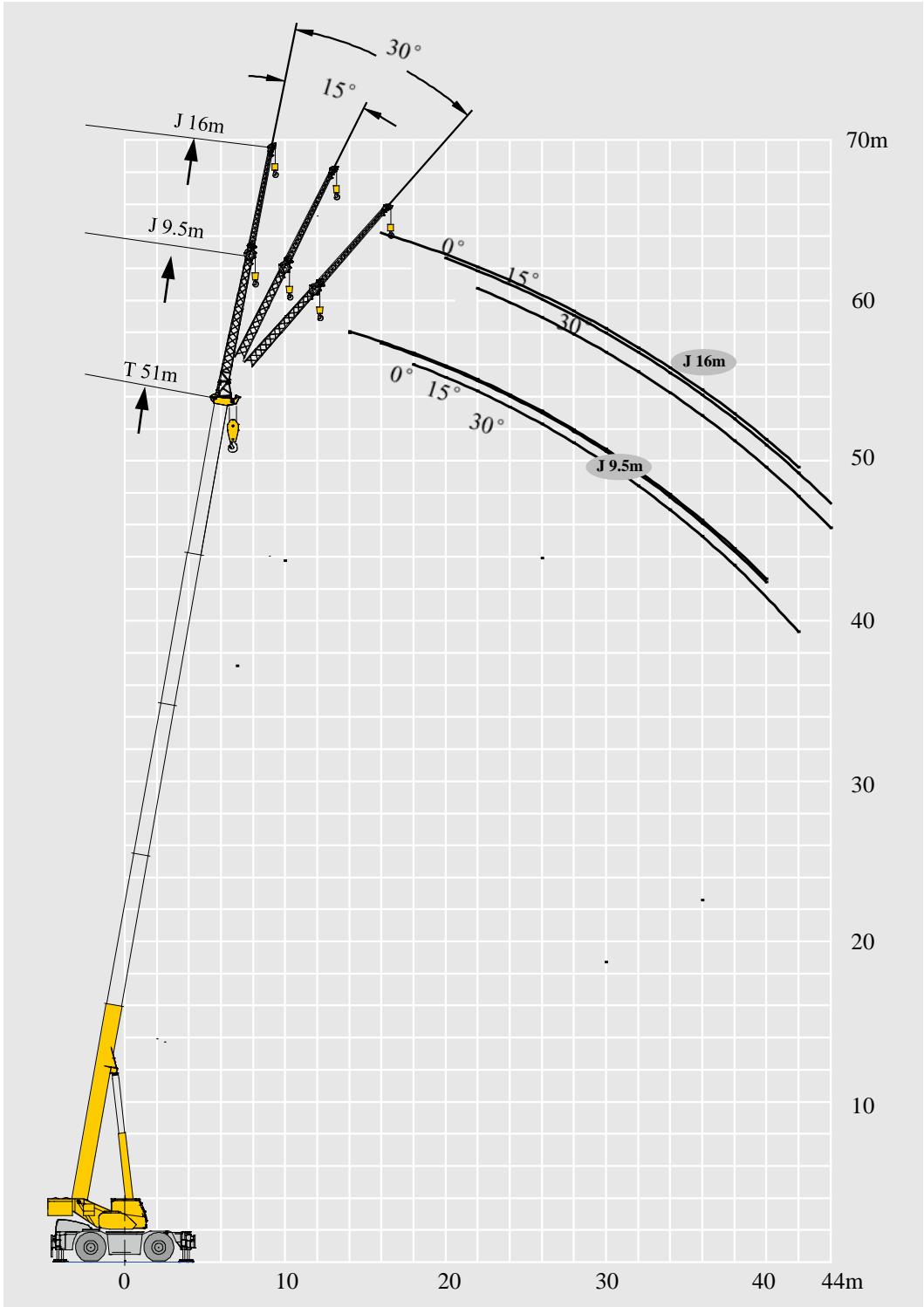

起重性能表

Lifting capacities

J 9.5-16m

m	51 m+9.5m			m
	0°	15°	30°	
14	6			14
16	5.8	4.8		16
18	5.6	4.8	3	18
20	5.3	4.6	2.8	20
22	5.1	4.5	2.7	22
24	4.9	4.4	2.5	24
26	4.4	4.1	2.4	26
28	3.7	3.9	2.2	28
30	3.1	3.4	2.2	30
32	2.6	2.8	2.2	32
34	2.1	2.3	2.1	34
36	1.7	1.9	2.1	36
38	1.4	1.6	1.7	38
40	1.1	1.2	1.3	40
42			1	42















m	51 m+16m			m
	0°	15°	30°	
16	3			16
18	3			18
20	3	2		20
22	3	1.9	1.3	22
24	2.9	1.8	1.2	24
26	2.8	1.8	1.1	26
28	2.7	1.7	1.1	28
30	2.6	1.6	1.1	30
32	2.6	1.5	1	32
34	2.4	1.4	1	34
36	2	1.4	1	36
38	1.7	1.3	0.9	38
40	1.4	1.3	0.9	40
42	1.1	1.2	0.9	42
44		1.1	0.9	44

符号标识

Description of symbols

常规标识

Symbol glossary

	支腿 Outriggers		车桥 Axle
	工作幅度 Radius		行驶速度 Driving speed
	吊臂仰角 Boom angle		爬坡能力 Grade ability
	吊臂长度 Boom length		轮胎 Tires
	吊钩 Hook block		平衡重 Counterweight
	360°全回转 360° rotation		上车 Superstructure
	卷扬 Winch		越野轮胎起重机 Rough terrain crane

起重作业标识

Crane specific symbols

	主臂 Boom		副臂 Jib
--	------------	---	-----------

主要技术参数表

Table of main technical parameters

类别 Category	项目 Item	单位 Unit	参数 Parameter	允差范围 Allowance	
尺寸参数 Dimensions	外形尺寸 (长×宽×高) Outline size (length×width×height)	mm	15288×3300×3893	±1%	
	轴距 Wheel base	mm	4100	±1%	
	轮距 (前/后) Track (Front/ Rear)	mm	2520/2520	±1%	
	前悬/后悬 Front/ Rear overhang	mm	2415/2421	±1%	
	前伸/后伸 Front/ Rear extension	mm	6273/79	±1%	
重量参数 Weight	整车总质量 Gross vehicle weight	kg	58910	±3%	
	轴荷 Axle load	一轴 1st axle	kg	29340	±3%
		二轴 2nd axle	kg	29570	±3%
动力参数 Power	发动机型号 Engine model	—	ISD285 50	—	
	额定功率/转速 Engine rated power/rpm	kW/(r/min)	210/2500	—	
	最大输出扭矩/转速 Engine rated torque/rpm	N.m/(r/min)	1020/(1300-1500)	—	
行驶参数 Travel	最高车速 Max. travel speed	km/h	≥35	—	
	最低稳定车速 Min. travel speed	km/h	1.3	—	
	最小转弯直径 Min. turning diameter	m	≤13.6	—	
	最小离地间隙 Min. ground clearance	mm	524	±1%	
	接近角 Approach angle	°	20.1	±1°	
	离去角 Departure angle	°	20.1	±1°	
	制动距离 (制动初速度为 24km/h) Braking distance (at 24 km/h)	m	≤9	—	
	最大爬坡能力 Max. grade ability	%	≥76	—	

主要技术参数表

Table of main technical parameters

类别 Category	项目 Item		单位 Unit	参数 Parameter	允差范围 Allowance	
主要性能参数 Main performance	最大额定总起重量 Max. total rated lifting capacity		t	110	±5%	
	最小额定工作幅度 Min. rated working radius		m	2	±1%	
	转台尾部回转半径 Turning radius at turntable tail	平衡重处 Counterweight	mm	4600	±1%	
	最大起重力矩 Max. load moment	基本臂 Base boom	kN.m	3057.6	±5%	
		最长主臂 Fully-extended boom	kN.m	1711.1	±5%	
	支腿跨距 Outrigger span	纵向 Longitudinal	m	7.8	±1%	
		横向 Lateral	m	7.8	±1%	
	起升高度 Hoist height	基本臂 Base boom	m	13.9	±1%	
		最长主臂 Fully-extended boom	m	50.6	±1%	
		最长主臂+副臂 Fully-extended boom + Jib	m	64.2	±1%	
	起重臂长度 Boom length	基本臂 Base boom	m	13.05	±1%	
		最长主臂 Fully-extended boom	m	51	±1%	
		最长主臂+副臂 Fully-extended boom + Jib	m	67	±1%	
副臂安装角 Jib offset angle			°	0、15、30	—	
工作速度参数 Working speed	起重臂起臂时间 Boom raising time		s	55	—	
	起重臂全伸时间 Boom fully extending time		s	130	—	
	最大回转速度 Max. slewing speed		r/min	1.6	—	
	支腿收放时间 Outrigger extending and retracting time	水平支腿 Outrigger beam	收 Retracting	s	35	—
			放 Extending	s	40	—
		垂直支腿 Outrigger jack	收 Retracting	s	45	—
			放 Extending	s	50	—
	起升速度 (单绳,第四层,空载) Hoisting speed (single line, 4th layer, no load)	主起升机构 Main winch	m/min	145	—	
副起升机构 Auxiliary winch		m/min	90	—		

注意事项

Notes

1. 表中额定总起重量值，是在平整的坚固地面上本起重机能够保证的最大总起重量，包括吊钩和吊具的重量，所以为了估算重物重量，必须减去上述的装置重量。
 2. 表中的工作幅度为起吊重物离地时起重物到起重机回转轴线的水平距离，是包括起重臂变形量在内的实际值，因而起吊前应考虑起重臂变形量。
 3. 只允许在5级(瞬时风速14.1m/s，风压125N/m²)风以下进行作业。
 4. 吊重前操作者必须对物体的重量和工作范围了解后选择合适的作业工况，严禁超出表中的数值。幅度及臂长在相邻两个数值之间时，应依据两个数值中较小值确定起重作业。
 5. 应按主臂仰角范围作业，即使是空载，也不应使主臂仰角处于范围外，谨防整机倾翻。
 6. 表中的主臂长度应要按照每节臂的伸缩要求进行伸出。
1. The total rated loads given in the rated load charts are the maximum lifting capacity when the crane is set up on firm and level ground, which includes the weight of the hook block and slings. The weight of above-mentioned devices should be deducted from the rated lifting load.
 2. The working radius shown in the rated load charts is the radius when the load is lifted off the ground, and it is the actual value including loaded boom deflection. Take boom deflection into consideration before beginning a lifting operation.
 3. A lifting operation is permissible only when the wind force is below grade 5 (instantaneous wind speed is 14.1 m/s, wind pressure is 125 N/m²).
 4. Before beginning lifting operation, the operator should know the weight of the load to be lifted and its working range, and then select proper working conditions. Never operate the crane beyond the limit shown in the chart. Use the lower value from the chart when the boom length or working radius is between the range of values.
 5. Observe the boom angle limit. Never operate the crane with the boom angle beyond the recommended limit even if a load is not being carried. Otherwise, the crane will tip.
 6. The boom should be extended according to the telescoping code shown by digits, which means the percentage of boom sections extended.



地址：江苏省徐州市经济技术开发区高新路68号

Add : No. 68 Gaoxin Road, Economic and Technological
Development Zone, Xuzhou, Jiangsu, China

电话(Tel) : +86-516-83462242/83462350

质量监督电话(Quality Inquiry Tel) : +86-516-87888268

备件电话(Spare Parts Tel) : +86-516-83461542

邮编(Post Code) : 221004

网址(Web) : www.xcmg.com/qizhongji

服务热线 Service Tel

400-110-9999

400-001-5678



本印刷品不属于合同。出于产品不断改进的需要，我们保留对产品型号、参数、配置进行变更的权利，恕不另行通知。图片仅供参考，具体产品以实物为准。图片中产品可能并非标准配置，部分部件可能需要另行购置。办理牌照和上路行驶需遵守当地法规。

This print does not belong to the contract. We reserve the right to modify the design (such as product model, parameters and configuration) without notice for improvement. The pictures are just for reference. The product in the picture may not be standard configuration. Some parts need to be purchased separately. Conform to the local laws for license application and road traveling.